



Ultrasonic heat and cooling energy meters WSM5..

Ultrasonic meters to measure flow and energy in hydronic heating or cooling circuits.

- Non-wearing due to non-moving parts
- Approved in accordance with EN 1434 and MID accuracy class 2
- Compact meters with flow measuring section made of high-tech plastic
- Mounting position optional (horizontal or vertical), return or flow
- Measuring range of flow 1:100 conforming to EN 1434 (total range 1:1000)
- No inlet or outlet settling paths required
- Optical interface conforming to EN 62056-21
- M-bus communication (optional)
- Self-diagnostics

Use

The WSM5.. is a measuring instrument used for the physically correct acquisition of energy consumption. The device consists of a flow measuring section made of high-tech plastic, 2 ready connected temperature sensors, and an electronic unit which calculates the energy consumption from the flow and the temperature differential. The WSM5.. is of compact design and therefore ideally suited for use in apartments. It is available in different versions for metering heat or cooling energy.

Restrictions

The temperature sensors and battery of the WSM5.. cannot be replaced.

Functions

Meter design

The meter consists of electronic unit, flow measuring section and 2 temperature sensors. The electronic unit is equipped with longlife batteries, ensuring up to 11 years of operation.

Ultrasonic measuring principle

The flow is acquired based on the non-wearing ultrasonic measuring principle, which requires no moving parts.

The amount of energy transferred from the medium to the consumer over a defined period of time is proportional to the temperature differential between flow and return and the volume of water that has passed through.

The **water volume** is measured in the measuring tube by ultrasonic pulses which are transmitted in the direction of flow and against the direction of flow. Downstream, the time difference between the transmitter and receiver is reduced, upstream it is increased. The water volume is then calculated using the measured values of the time difference.

The **flow and return temperatures** are acquired by platinum resistors.

The water volume and the temperature differential between flow and return are multiplied and the product integrated. The result, which is the consumed **amount of thermal energy**, is stored and displayed in the physical units **kWh/MWh or MJ/GJ**, the volume in **m³**.

The WSM5.. uses an **intelligent, adaptive temperature-measuring interval**. With changing system conditions (e.g. rapid increase of flow), the WSM5.. changes for a certain time to a fast temperature-measuring interval. Thus, the meter always adapts itself to the current situation and acquires the system temperatures very accurately.

Electronic unit

A standard electronic unit is used for all measuring tubes with an integrated service unit.

Optical communication interface

The WSM5.. is equipped with an optical communication interface which facilitates readout and parameterization on site with the help of the optical read head WZR-OP-USP and matching UltraAssist software.

M-bus communication (optional)

If the meter uses M-bus communication, it can be read out from a remote location via an M-bus master unit.

Tampering

To open the device, the calibration seal at the top of the WSM5.. must be destroyed.

Self-diagnostics

The meter makes constantly self-diagnostics, enabling it to detect and display various installation and device errors.

Type summary WSM5..

The types of meters listed below are equipped as follows:

Mounting location	Return
Rated pressure	PN 16
Length of control cable	1.5 m
Sensor mounting	Return sensor, integrated in the flow measuring section
Temperature sensor type	Pt500, Ø 5.2 mm, length = 45 mm
Temperature sensor cable length	1.5 m
Approval	EN 1434 class 2 MID 2004/22/EG
Energy unit	kWh

	<i>Options</i>	<i>Stock number</i>	<i>Product no.</i>
Rated flow 0.6 m³/h	Mounting length 110 mm, connecting thread G ¾ ", battery life 6 years without communication	LYU:WSM506-0A	WSM506-0A
	Mounting length 110 mm, connecting thread G ¾ ", battery life 11 years without communication	S55561-F133	WSM506-0E
	Mounting length 110 mm, connecting thread G ¾ ", battery life 11 years, M-bus	S55561-F194	WSM506-BE
Rated flow 1.5 m³/h	Mounting length 110 mm, connecting thread G ¾ ", battery life 6 years without communication	LYU:WSM515-0A	WSM515-0A
	Mounting length 110 mm, connecting thread G ¾ ", battery life 11 years without communication	S55561-F135	WSM515-0E
	Mounting length 110 mm, connecting thread G ¾ ", battery life 11 years, M-bus	S55561-F195	WSM515-BE
Rated flow 2.5 m³/h	Mounting length 130 mm, connecting thread G 1", battery life 6 years without communication	LYU:WSM525-0A	WSM525-0A
	Mounting length 130 mm, connecting thread G 1", battery life 11 years without communication	S55561-F137	WSM525-0E
	Mounting length 130 mm, connecting thread G 1", battery life 11 years, M-bus	S55561-F196	WSM525-BE

Accessories for WSM5..

<i>Component</i>	<i>Stock number</i>	<i>Product no.</i>
Mounting kit, consisting of: - 2 coupling nuts G 3/4" - 2 inserts R 1/2" - 2 packings made of EPDM	LYU:T23-E34	T23-E34
Mounting kit, consisting of: - 2 union nuts G 1" - 2 inserts R 3/4" - 2 packings made of EPDM	LYU:T23-E1	T23-E1
Ball valve R 1/2" with union nut G 3/4"	LYU:WZT-K12-34	WZT-K12-34
Ball valve R 3/4" with union nut G 3/4"	LYU:WZT-K34-34	WZT-K34-34
Ball valve R 3/4" with union nut G 1"	LYU:WZT-K34-1	WZT-K34-1
Ball valve R 1" with union nut G 1"	LYU:WZT-K1-1	WZT-K1-1

<i>Component</i>	<i>Stock number</i>	<i>Product no.</i>
Adapter G 3/8 B" with threaded hole M10x1 mm for sensor, incl. gasket G 3/8" made of copper	LYU:WZT-A38	WZT-A38
Adapter G 1/2 B" with threaded hole M10x1 mm for sensor, incl. gasket G 1/2" made of copper	S55563-F116	WZT-A12
Adapter G 3/4 B" with threaded hole M10x1 mm for sensor, incl. gasket G 3/4" made of copper	LYU:WZT-A34	WZT-A34
Protection pocket G 1/2 B" made of brass, Ø 5.2x35 mm for sensor Ø 5.2x45 mm	S55563-F103	WZT-M35
Adapter kit, consisting of: - 1 plastic adapter Ø 5.2x45 mm - 1 mounting aid for sensor Ø 5.2x45 mm - 2 O-rings	LYU:9956230	9956230
Spacer G 3/4", length 110 mm, incl. 2 gaskets	LYU:WZM-G110	WZM-G110
Spacer G 1", length 130 mm, incl. 2 gaskets	LYU:WZM-G130	WZM-G130
Sealing disk G 3/4", for threaded connection R 1/2"	LYU:9060944002	9060944002
Sealing disk G 1", for threaded connection R 3/4"	LYU:9060944003	9060944003
Welding sleeve with threaded hole for temperature sensor DS M10x1 mm	S55563-F121	WZT-G10
10 wall adapters for mounting the electronic unit on the wall, incl. 2 screws and 2 dowels	LYU:T23-WA10	T23-WA10
10 EPDM gaskets for mounting the flow measuring section 3/4"	LYU:T23-34EPDM10	T23-34EPDM10
10 EPDM gaskets for mounting the flow measuring section 1"	LYU:T23-1EPDM10	T23-1EPDM10
Programming accessories		
Optical read head with USB plug for PC interface	LYU: WZR-OP-USB	WZR-OP-USB
Readout and parameterization software - UltraAssist Light	Download	WZX-UA-L
- UltraAssist Standard, first license, CD with dongle for printer interface	LYU:WZX-UA-SED	WZX-UA-SED
- UltraAssist Standard, second license with dongle for printer interface	LYU:WZX-UA-SFD	WZX-UA-SFD
- UltraAssist Standard, first license, CD with dongle as PCMCIA card	LYU:WZX-UA-SEP	WZX-UA-SEP
- UltraAssist Standard, second license with dongle as PCMCIA card	LYU:WZX-UA-SFP	WZX-UA-SFP
- UltraAssist Standard, first license, CD with dongle for USB interface	LYU:WZX-UA-SEU	WZX-UA-SEU
- UltraAssist Standard, second license with dongle for USB interface	LYU:WZX-UA-SFU	WZX-UA-SFU

Ordering

When ordering, please give quantity, description, product no. and stock number.

Order numbers

Product no.	Stock number	Description
WSM506-0E	S55561-F133	Ultrasonic heat meter

Scope of delivery

The WSM5.. is supplied complete with Mounting Instructions in different languages, an adapter kit, 2 gaskets and a seal.

Languages

The Mounting Instructions are supplied in 18 languages:
Bulgarian, Chinese, Czech, Dutch, English, French, German, Greek, Hungarian, Italian, Norwegian, Polish, Russian, Serbo-Croatian, Slovakian, Slovenian, Spanish and Turkish.

Technical design

Metering accuracy as per EN 1434

The diagram below shows the typical accuracy of the WSM5.. in comparison with the error limits as per to EN 1434 class 2.

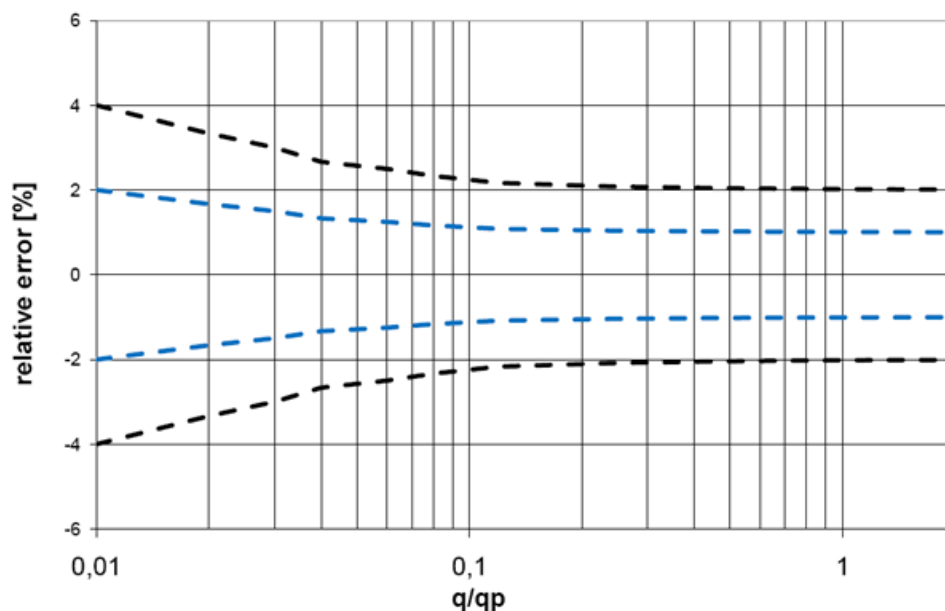

Legend:
- - - WSM5.. typical
- - - EN 1434 class 2

Pressure loss characteristics

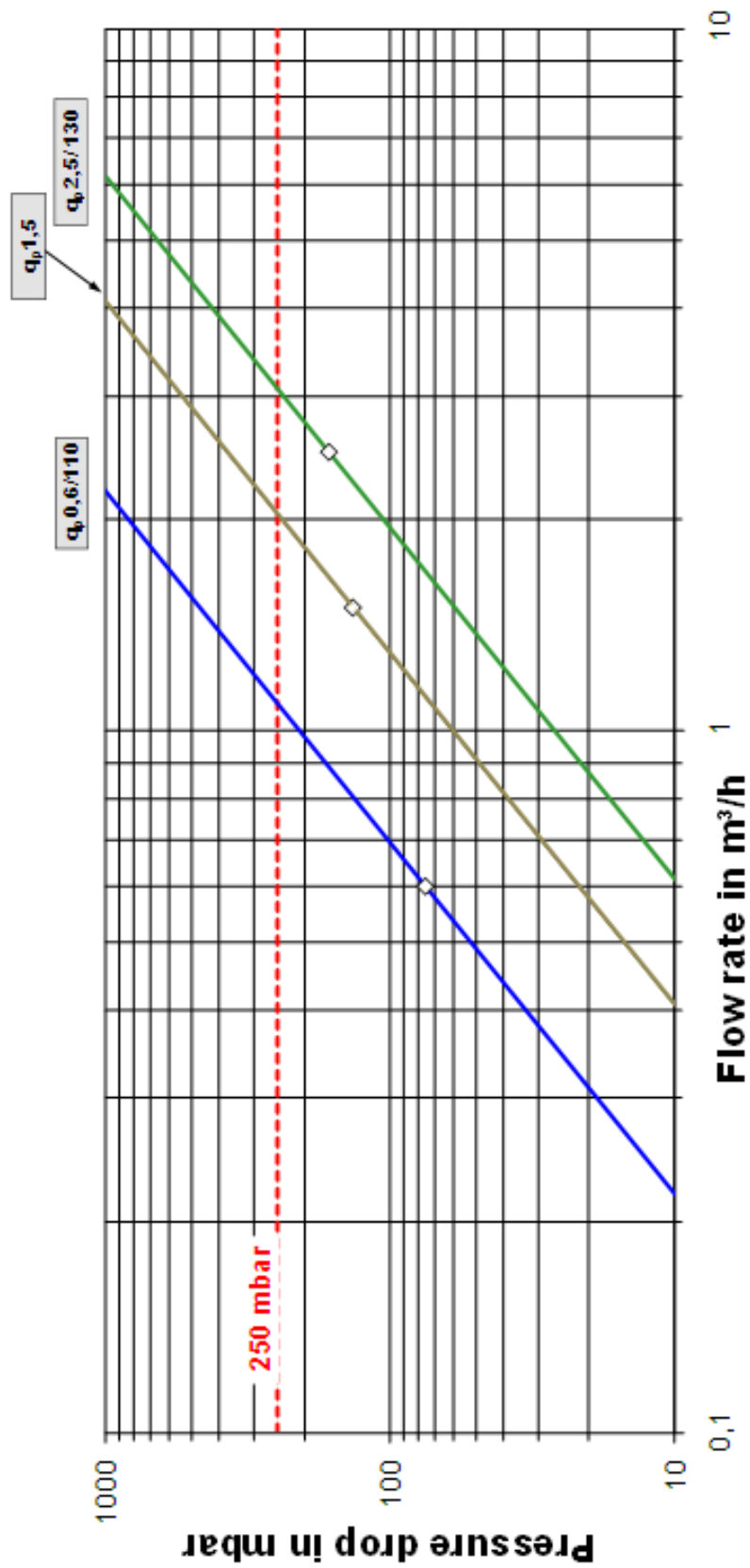

The WSM5.. has a large, easy-to-read LCD with 7 digits to display different values (e.g. energy or flow). This new type of dynamic display enables users to identify positive flow at a glance. Icons for previous year values and previous month values support the easy-to-understand display concept.

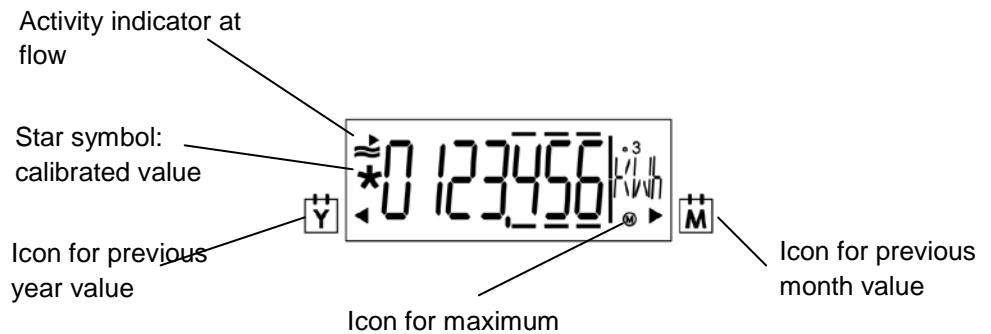

The meter's display is subdivided into several loops.

A short press on the button (<2 s) lets the current loop pass through line by line. After the last line, the first line is displayed again. A long press (>3 s) displays the first line of the next loop. After the last loop, the first loop reappears.

The arrow icons mark the display of a stored value of the previous year or previous month. A calibrated value (e.g. energy) is marked on the display by a star symbol. The decimal places of displayed values are indicated by a frame.



User loop LOOP 0	1234567	kWh	Energy
	1234567	m ³	Volume
	0000000		Segment test
	F-----		In case of error message with error code
Current values LOOP 1	1234567	m ³ /h	Current flow
	1234567	kW	Current thermal power
	80,0	°C	Current flow temperature
	50,0	°C	Current return temperature
	Bd 1234	h	Operating time
	Fd 123	h	Missing time
	Pd 1234	h	Time with flow rate
Previous month values LOOP 2	01.06.2011		Monthly date (due date) saving day
	1234567	kWh	Monthly value (due date) energy on set day
	1234567	m ³	Monthly value (due date) volume on set day
	Fd 123	h	Missing time on set day
	3,123	m ³ /h	Max. flow rate
	03.02.10		Date stamp of max. flow rate
	279,4	kW	Max. power
	03.02.10		Date stamp of max. power
	93,7	°C	Max. flow temperature
	03.02.10		Date stamp of max. flow temperature
	64,8	°C	Max. return temperature
	03.02.10		Date stamp of max. return temperature
General/ communication LOOP 3	1234567		Device number, 7 digits
	MbuS		Interface (only for M-bus)
	127A		Primary address (only for M-bus)
	0000000A		Secondary address (only for M-bus)
	01.01		Due date (yearly set day)
	01.--.--		Monthly value (monthly set day)
	I 5-00	FW	Firmware version
	CrC 1234		CRC code, part requiring calibration
Other LOOP 4	17.11.11		Current date [TT.MM.JJ]
	10.38.57		Current time of day [hh.mm.ss]
	-----	C	Code entry for test/parameter operation

Error codes

The meter performs self-diagnostics continually and can thus detect and display different installation or device errors:

FL	nEG	Wrong direction of flow
DIFF	nEG	Negative temperature differential
F0		No flow measurable
F1		Break in supply sensor
F2		Break in return sensor
F3		Electronics for temperature evaluation faulty
F4		Battery exhausted
F5		Short-circuit in flow sensor
F6		Short-circuit in return sensor
F7		Disruption of internal memory operation
F8		F1, F2, F3, F5 or F6 persist longer than 8 hours Detection of tampering No more measurements made
F9		Electronics faulty

Previous year values

The electronic unit stores the meter readings for energy, volume, missing time, and flow measuring time as well as the current maximum values of flow rate, power, flow and return temperature with their date stamps on a yearly set day. The set day for previous year values can be parameterized.

Monthly values

The electronic unit stores the meter readings for energy, volume, missing time, and flow measuring time as well as the monthly maximum values of flow rate, power, flow and return temperature with their date stamp for up to 24 months on the set day of each month.

The set day for previous monthly values can be parameterized.

In addition, a second programmable monthly set day is available for 24 months – the day on which energy and volume are stored.

Standard parameters

The WSM5.. comes programmed as follows:

- Set day [TT.MM]: 01.01

Mounting

Flow measuring section

The mounting orientation is optional, the mounting location (return or flow) must correspond to the type of meter used.

Inlet or outlet settling paths are not required.

If the meter is installed in the common return of 2 heating circuits (e.g. space heating and DHW), the mounting location must be in an adequate distance from the T-piece (min. 10 x DN) to allow the different water temperatures to properly mix.

Before mounting the meter, the system must be properly flushed.

Mount the flow measuring section between 2 shutoff valves with the arrow pointing in the direction of flow. The sensors must be mounted in the same water circuit as the flow measuring section (observe mixing). The sensors can be fitted in T-pieces, ball valves, direct immersed or in pockets (national regulations must be observed). In any case, the end of the sensors must extend to at least the pipe center. Temperature sensors and fittings must be sealed to prevent tampering.

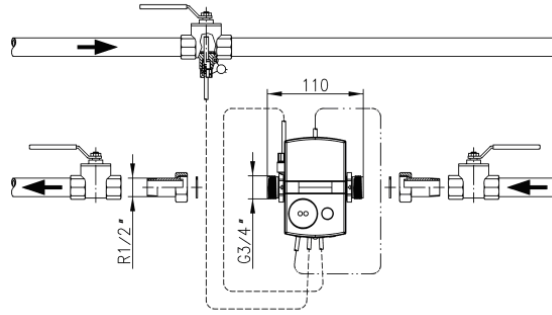

Mounting with ball valve

Electronic unit

The ambient temperature of the electronic unit must not exceed 55 °C. Direct solar irradiance must be avoided.

With water temperatures between 10 °C and 90 °C, the electronic unit can be left on the flow measuring section or can be fitted to a wall (detached mounting). The adapter plate on the wall or the flow measuring section can be aligned as needed to ensure ease of reading. To remove the electronic unit, turn the housing by 45° to the side and lift it up.

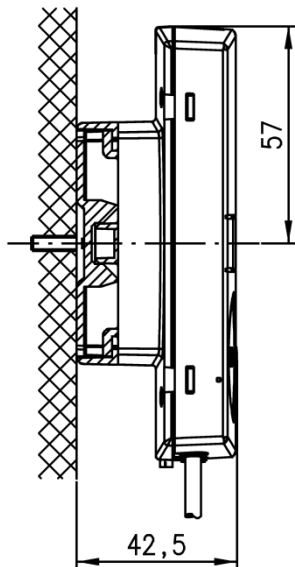

Wall mounting

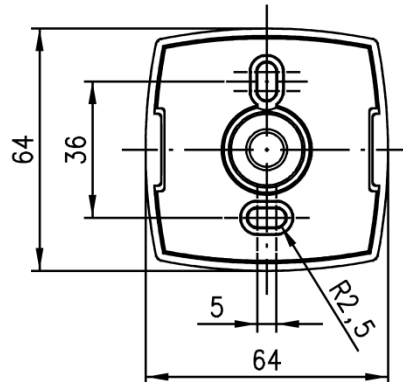

Wall adapter (view from above)

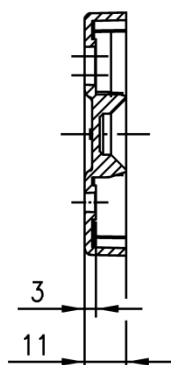

Wall adapter (side view)

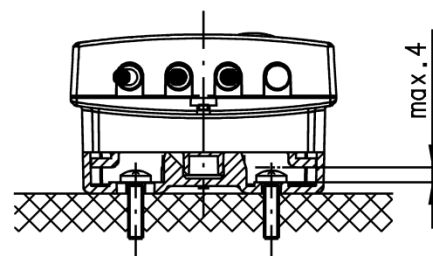

Maximum screw head height
(if using the wall bracket)

Maintenance notes

Maintenance

The meters are maintenance-free.
National calibration regulations must be observed.

Disposal



The devices are considered electronics devices for disposal in terms of European Directive 2012/19/EU and may not be disposed of as domestic waste.

- Dispose of the device via the channels provided for this purpose.
- Comply with all local and currently applicable laws and regulations.
- Dispose of empty batteries at designated collection points.

Warranty service

The application-related technical data are only guaranteed together with the products mentioned in this Data Sheet.

If the meters are used in connection with third-party devices that are not explicitly mentioned, the user must ensure proper functioning. In that case, Siemens will not provide any services and warranty.

Technical data

Electronic unit

Power supply	Battery type	Lithium battery (cannot be replaced)
	Battery power	3.6 V
	Battery service life	6 or 11 years
Function data	Measuring range	0...180 °C
	Range of temperature differential $\Delta\Theta$	3...80 K
	Temperature response threshold	0.2 K
	Thermal coefficient	Shifting-compensated
	Temperature-measuring error without sensor	$(0.5 + \Delta\Theta_{\min.} / \Delta\Theta) \%$, max. 1.5 % at $\Delta\Theta = 3$ K
Temperature sensors	Sensing element	Pt500
	Type	Ø 5.2 x 45 mm

Flow measuring section

Function data	Temperature range	5...90 °C			
	(national approvals may differ)				
	Max. temperature $t_{\max.}$	°C	90		
	Rated pressure	MPa	1.6 (PN 16)		
	Rated flow q_p	m ³ /h	0.6	1.5	2.5
	Metrological class		1:100	1:100	1:100
	Max. flow q_s	m ³ /h	1.2	3	5
	Min. flow q_i	l/h	6	15	25
	Response threshold	l/h	1.2	3	5
	Pressure loss at q_p				
	Mounting length 110 mm Δp	mbar	75	135	---
	Mounting length 130 mm Δp	mbar	---	135	165
	Flow rate at $\Delta p = 1$ bar, K_v	m ³ /h	2.2	4.1	6.2
	Mounting orientation	Optional			

Communication

	Optical interface	
	- Design	Similar to EN 62056-21
	- Protocol	As per EN 13757-2 / -3
Cable length	M-bus interface	Optional
	- Voltage $V_{\max.}$	50 V
	- Current draw	1 M-bus load
	- Addressing	Primary and secondary
	- Baud rate	300 or 2,400 baud
	- Max. permissible reading frequency	1x per minute
	- Protocol	As per EN 13757-2/-3, EN 1434-3
	- Connecting cable length and cross sectional area	1.5 m, 2x AWG24/0.2 mm ²
	Control cable	1.5 m
Protection data	Safety class	III
	Degree of protection	
	- Electronic unit	IP54
	- Flow measuring section	IP65

Ambient conditions

	Operation EN 60721-3-3	Transport EN 60721-3-2	Storage EN 60721-3-1
Climatic conditions	Class A	Class A	Class A
Temperature	5...55 °C	-20...60 °C	-20...60 °C
Humidity	<93% r.h. at 25 °C (non- condens- ing)	<93% r.h. at 25 °C (non- condens- ing)	<93% r.h. at 25 °C (non- condens- ing)
Mechanical conditions	Class M1	Class M1	Class M1
Max. altitude	Min. 700 hPa, corresponding to max. 2000 m above sea level		

Directives and standards

Product standard	DIN EN 1434-x (heat meters)
EU Conformity (CE)	CE2T5372xx *)
RCM Conformity	CE2T5372en_C1 *)

Environmental compatibility

The product environmental declaration CE2E5372en contains data on environmentally compatible product design and assessments (RoHS compliance, materials composition, packaging, environmental benefit, disposal).

Dimensions

(W x H x D):	
- Electronic unit	116 x 71 x 32 mm
- Flow measuring section	110 x 43 x 64 mm (without cable)

Housing material

Cover	ABS
Bottom section	PC GF10
Battery compartment	PC clear

Housing colors

Cover	RAL 9006
Bottom section	RAL 9002

Weight

Device packed with accessories	1 kg
--------------------------------	------

*) The documents can be downloaded from <http://siemens.com/bt/download>.

Connection diagram

For meters with M-bus communication

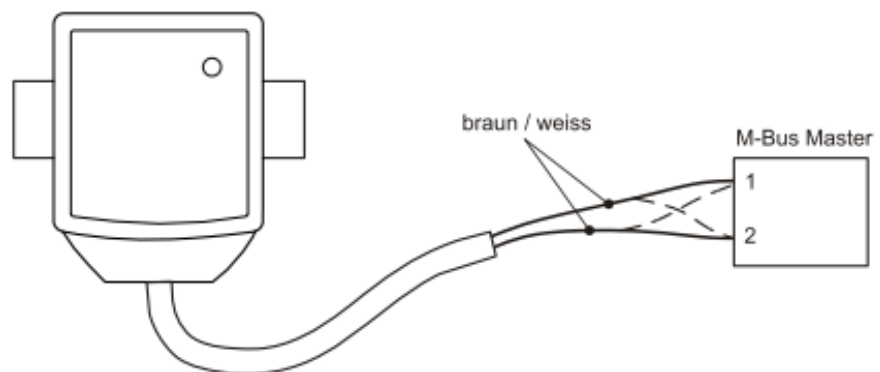

5375AUC03M

Dimensions

Dimensions in mm

